

SUPPLEMENT
TO THE
NEW ZEALAND GAZETTE

OF
THURSDAY, MAY 3, 1906.

Published by Authority.

WELLINGTON, THURSDAY, MAY 3, 1906.

CONTENTS.

	Page
Notice	1177
Official Notices	1177
Applications for Letters Patent filed	1178
Complete Specifications accepted	1179
Provisional Specifications accepted	1181
Letters Patent sealed	1181
Letters Patent on which Fees have been paid	1181
Subsequent Proprietors of Letters Patent registered	1182
Applications for Letters Patent abandoned	1182
Applications for Letters Patent void	1182
Applications for Letters Patent lapsed	1182
Letters Patent void	1182
Design registered	1182
Applications for Registration of Trade Marks	1183
Trade Marks registered	1186
Trade Mark Renewal Fees paid	1187
Subsequent Proprietors of Trade Marks registered	1187
Trade Marks removed from the Register	1187
Request for Correction of Clerical Error allowed	1187
Notice <i>re</i> Advertisements	1187
Illustrations of Inventions.	

Notice.

CLASSIFIED abridgments of inventions patented in the United Kingdom from 1900 to 1904 are now available for inspection in the library attached to this office.

Official Notices.

THE following publications relating to Patents for inventions, &c., are open to inspection in the colony:—

WELLINGTON.—PATENT OFFICE LIBRARY.

United Kingdom.

The full text of the specifications and complete drawings of inventions patented from the year 1617 up to the 25th January, 1906.

Classified abridgments of inventions from 1855 to 1904.

A

Illustrated Official Journal, containing lists of recent applications, abridgments of inventions for which patents have been lately granted, patents void, &c., to March, 1906.

Index of Applicants.
Subject-matter Index.
Commissioner of Patent Journal, &c.(*)
Trade Marks Journal to February, 1906.

Canada.

Patent Office Record (containing illustrated abridgments of inventions, &c.) to September, 1905.

Australia.

The Official Journal of Patents of the Australian Commonwealth (containing lists of applications for letters patent, abridgments of complete specifications accepted, &c.).

The Gazettes of the various States (containing lists of applications for registration of trade marks, &c.).

Specifications, drawings, abridgments, and indexes of Victoria, New South Wales, Queensland, and South Australia(b).

United States.

The Official Gazette of the United States Patent Office (containing illustrated abridgments of specifications, &c.) to March, 1906.

Mexico.

The Official Gazette of the Patent and Trade Mark Office.

General.

La Propriété Industrielle (the official organ of the International Bureau of the Union for the Protection of Industrial Property).

Patent laws of the world.
Patent and Trade Mark Review.
Text-books and handbooks on patents and trade marks.

AUCKLAND.—PUBLIC LIBRARY.

United Kingdom.

Classified abridgments of inventions from 1855 to 1900.
Illustrated Official Journal from 1897 to date.

Canada.

Patent Office Record (containing illustrated abridgments of inventions, &c.) from 1897 to date.

Australia.

The Official Journal of Patents from 1905 to date.

United States.

The Official Gazette of the United States Patent Office (containing illustrated abridgments of specifications, &c.) from 1885 to 1887 and 1890 to 1895.

CHRISTCHURCH.—PUBLIC LIBRARY.

United Kingdom.

Classified abridgments of inventions from 1855 to 1900.
Illustrated Official Journal from October, 1905, to date.

Canada.

Patent Office Record (containing illustrated abridgments of inventions, &c.), from 1897 to date.

Australia.

The Official Journal of Patents from 1905 to date.

DUNEDIN.—TOWN HALL.

United Kingdom.

Classified abridgments of inventions from 1855 to 1900.
Illustrated Official Journal from October, 1905, to date.

BOOKS AND DOCUMENTS OPEN TO INSPECTION.

The following documents and books are open to public inspection at the Patent Office:—

Patents.

(Fee for each search or inspection, not exceeding one hour, 1s.)

1. The files relating to all applications for letters patent in respect of which complete specifications have been accepted.
2. Classified copies of specifications and drawings, with index and key^(c).

3. Register of Application for Letters Patent.

4. Register of Patents.

5. Register of Subsequent Proprietors of Letters Patent^(d).

6. Index of Patentees^(e).

7. Index of Proprietors of Letters Patent granted prior to 1890^(f).

8. Index of Specifications^(g).

Designs.

(Search fee, 1s. each quarter of an hour.)

1. Register of Designs, with Index of Names of Proprietors.

2. Classified Representations of Designs in respect of which Copyright has expired.

3. Index of Designs.

Trade Marks.

(Search fee, 1s. each quarter of an hour.)

1. The files relating to all applications for registration of trade marks.

2. Register of Applications for Registration of Trade Marks.

3. Register of Trade Marks.

4. Index of Applicants for Registration of Trade Marks^(h).

5. Index of Trade Marks.

6. Classified Representations of Trade Marks, with indexes.

Miscellaneous.

Register of Patent Agents.

FORMS.

The following forms, &c., may be had on application:—

Application for letters patent.

Provisional specification.

Complete specification and copy thereof.

Application for registration of design.

Application for registration of trade mark.

Applications for extension of time.

Requests by subsequent proprietor to enter name on Register of Patents and Trade Marks.

Printed sheets of information as to fees and procedure to obtain letters patent and to register a trade mark⁽ⁱ⁾.

Pamphlet containing Act and Regulations (price 1s.).

OFFICIAL PUBLICATIONS.

The following publications may be obtained from the Government Printer, Wellington:—

Printed specifications to the end of the year 1879.

Annual lists of letters patent and letters of registration applied for, and particulars of applications lapsed, and patents lapsed, from 1880 to 1888 inclusive.

Annual reports of the Registrar, containing alphabetical lists of applicants for letters patent and of inventions patented from 1889 to 1904 inclusive.

The Patents Supplement to *Gazette* (containing notifications, applications for letters patent, abridged descriptions and drawings of inventions, &c.), published fortnightly.

LOCAL PATENT OFFICES.

Local patent offices for the reception of applications for letters patent without extra payment have been appointed at the following places: Ashburton, Auckland, Blenheim, Christchurch, Dunedin, Gisborne, Greymouth, Hokitika, Invercargill, Napier, Nelson, New Plymouth, Oamaru, Queenstown, Thames, Timaru, Wanganui, Westport. These are situated in the Supreme Court Buildings and S.M. Court Houses.

PATENT AGENTS.

A list of registered patent agents may be obtained on application.

- (a) Discontinued.
(b) In arrear. Not now being printed.
(c) Key is in card index.
(d) This Register contains only names of subsequent proprietors of letters patent granted prior to 1st January, 1890; since that date they appear in Register of Patents.
(e) Includes all names of applicants, &c., and consists of four volumes to 4th November, 1903, and card index since that date. A separate card index is kept for current quarter.
(f) The names of proprietors of subsequent letters patent appear in the Index of Patentees.
(g) Contains classified abridgments of specifications from 1881, with extracts from drawings from July, 1904.
(h) Names of applicants for registration and proprietors of trade marks are indexed at the beginning of the Registers up to 31st December, 1889; in separate volume up to 5th September, 1904; and since the latter date are in card index.
(i) May also be obtained at any local Patent Office or money-order office.

Applications for Letters Patent filed.

LIST of applications for Letters Patent filed. (Where a complete specification accompanies an application an asterisk is suffixed; in all other cases a provisional specification has been lodged. In cases where the applicant is not the inventor the name of the latter appears in italics after the title.)

No. 21006.—18th April.—J. Rusp, Stockdorf, Bavaria.

Flexible wheels.*

No. 21007.—18th April.—W. G. Mein and E. Gaminara, London, Eng.

Caster.*

No. 21008.—18th April.—International Telegraph Call Company, New York, U.S.A.

Electric signalling.* (*E. R. Gill.*)

No. 21009.—18th April.—Bifurcated Rivet Company, Limited, Warrington, Eng.

Rivet.* (*H. J. Joscelyne.*)

No. 21010.—18th April.—C. Ridd, Eltham, and D. Duncan, Oponake, N.Z.

Veterinary appliance.*

No. 21011.—18th April.—D. Ross and E. W. Pulver, Martinborough, N.Z.

Cigarette-holder.

No. 21012.—18th April.—A. H. Newman, Dannevirke, N.Z.

Pastry-mould.

No. 21013.—18th April.—F. J. Corbett, S. Yarra, Vic.

Food and tonic.

No. 21014.—18th April.—F. W. Bliss, Woodville, N.Z.

Gate-hinge.

No. 21015.—19th April.—W. H. Hughes, Sydney, N.S.W.

Cement.* (*R. Coskerie.*)

No. 21016.—19th April.—C. J. Walker, N. Fitzroy, Vic.

Boot-welting.

No. 21017.—19th April.—B. Crawford and H. A. Tattersall, Auckland, N.Z.

Boiler.

No. 21018.—12th April.—A. A. Pinches, Wanganui, N.Z.

Clothes-prop.

No. 21019.—18th April.—L. Hooker, Sydney, N.S.W.

Incandescent mantle.

No. 21020.—18th April.—C. Perkins, Onehunga, N.Z.

Non-refillable bottle.

No. 21021.—21st April.—A. L. Humphries, A. George, and W. H. Perham, New Plymouth, N.Z.

Football-cover.

No. 21022.—18th April.—A. Harris, Waimate, N.Z.

Insulator.

- No. 21023.—18th April.—A. G. Jackson, Brisbane, Queensland.
Cash-register.*
- No. 21024.—18th April.—A. McLeod, Dunedin, N.Z.
Smoke-consumer and gas-generator.
- No. 21025.—24th April.—G. Sage, Christchurch, N.Z.
Cement post.
- No. 21026.—24th April.—D. McKinnon, Dunedin, N.Z.
Seed-sower.
- No. 21027.—24th April.—C. E. Thompson, Moutere, N.Z.
Non-refillable bottle.
- No. 21028.—24th April.—T. C. Fowler, Palmerston N., N.Z.
Bicycle-frame.
- No. 21029.—21st April.—E. V. Gandil, Copenhagen, Denmark.
Milking-machine.*
- No. 21030.—21st April.—W. H. Tregoning and E. J. Riddick, Christchurch, N.Z.
Revolving fireplace.*
- No. 21031.—24th April.—W. R. Parcell, jun., Bannockburn, N.Z.
Protecting water-taps from frost.
- No. 21032.—20th April.—B. W. White, Wanganui, N.Z.
Preparing metal plates for printing.
- No. 21033.—20th April.—J. McMahon, Onehunga, N.Z.
Sling for lifting animals.
- No. 21034.—21st April.—I. Bagot and H. W. Cranswick, Birkenhead, N.Z.
Nailless horse-shoe.
- No. 21035.—25th April.—E. Janitzky, Pymble, J. F. Hamilton and J. T. Cummings, Croydon, N.S.W.
Preserving meat, &c.*
- No. 21036.—20th April.—J. H. L. Barry, Mataura, N.Z.
Apron for reaper-and-binder.
- No. 21037.—23rd April.—H. H. Reimers, Auckland, N.Z.
Copper boiler.*
- No. 21038.—26th April.—A. W. Burbury, Woodbury, Tas.
Securing strand of fencing-wire.
- No. 21039.—20th April.—D. Marshall, Invercargill, N.Z.
Picture-frame clamp.
- No. 21040.—25th April.—Duckworth, Turner, and Co., Limited, Christchurch, N.Z.
Sandal-strap.
- No. 21041.—25th April.—W. H. Davies, Melbourne, Vic.
Horse-shoe.*
- No. 21042.—24th April.—A. McLeod, Dunedin, N.Z.
Gold-saving.
- No. 21043.—27th April.—F. G. B., R., and H. Sanders, Wellington, N.Z.
Electric drilling-machine.
- No. 21044.—27th April.—A. E. Kellam, Sydney, N.S.W.
Lock-nut.
- No. 21045.—27th April.—R. Connell, Westport, N.Z.
Tire-inflator.
- No. 21046.—27th April.—B. A. Undrill, Invercargill, N.Z.
Hair-pin.
- No. 21047.—27th April.—A. E. and H. G. Bradley, Christchurch, N.Z.
Lead calme.
- No. 21048.—27th April.—E. D. Berry, Palmerston N., N.Z.
Milk-weighing.
- No. 21049.—28th April.—A. W. D. Meiklejohn, Big Omaha, N.Z.
Gum-digger's hook.
- No. 21050.—28th April.—G. Barrett, Alfriston, N.Z.
Boot-fastening.
- No. 21051.—28th April.—J. Richmond, Cromwell, N.Z.
Gold-saving.*
- No. 21052.—28th April.—R. Pierce and H. Wilkie, Kapaonga, N.Z.
Wire-strainer.*
- No. 21053.—26th April.—H. H. Adams, Takapuna, N.Z.
Preventing "racing" of marine propellers.
- No. 21054.—26th April.—J. McKay, Dunedin.
Window-fastener.
- No. 21055.—26th April.—J. Thomson, Waikaia, N.Z.
Bucket-lip.
- No. 21056.—30th April.—A. Baxter, Berhampore, N.Z.
Sliding-and-folding partition.
- No. 21057.—1st May.—T. S. Philpott, Wellington, N.Z.
Window.
- No. 21058.—1st May.—E. E. James, S. and H. E. Dunn, Balaclava, Vic.
Expandible pulley.
- No. 21059.—1st May.—W. E. Hughes, Wellington, N.Z.
Phonograph.* (C. C. Shigley.)

- No. 21060.—1st May.—W. E. Hughes, Wellington, N.Z.
Phonograph.* (C. C. Shigley.)
- No. 21061.—1st May.—J. S. Raworth, London, Eng.
Controller for electrically propelled vehicle.*
- No. 21062.—1st May.—P. C. Lawless, London, Eng.
Internal-combustion engine.*
- No. 21063.—1st May.—Queensland Meat Export and Agency Company, Limited, and D. Budge, Pinkenba, Q.
Box for butter, &c.*
- No. 21064.—28th April.—E. T. C. Firth, Auckland, N.Z.
Mixing and disintegrating machine.
- No. 21065.—28th April.—F. A. Rich, Auckland, N.Z.
Gas and oil stove.*
- No. 21066.—1st May.—H. Corbett, S. Yarra, Vic.
Syphon.
- No. 21067.—30th April.—A. Martin, Dunedin, N.Z.
Envelope and picture card.
- No. 21068.—2nd May.—D. Fabling, Feilding, N.Z.
Case-opening tool.
- No. 21069.—2nd May.—R. N. Saunders, Gisborne, N.Z.
Motor-tire.
- No. 21070.—2nd May.—D. G. McKenzie.
Change-giving register.*

Notice of Acceptance of Complete Specifications.

Patent Office,
Wellington, 2nd May, 1906.

COMPLETE specifications relating to the undermentioned applications for Letters Patent have been accepted, and are open to public inspection at this office. Any person may, at any time within two months from the date of this *Gazette*, give me notice in writing of opposition to the grant of any such patent. Such notice must set forth the particular grounds of objection, and be in duplicate. A fee of 10s. is payable thereon.

No. 18975.—16th January, 1905.—ALBERT JOHN WILEY and ROBERT GRAY, both of Morialta Street, Adelaide, South Australia, Australia, trading as manufacturers under the style of Wiley and Gray. A game and apparatus therefor.*

Extract from Specification.—Our invention consists of the improved game, and apparatus therefor, as described, and embodies improvements in the form of hinged wings or sides and pockets hitherto in use.

[NOTE.—The above extract from the specification is inserted in place of the claims.]

(Specification, 5s. ; drawing, 1s.)

No. 19506.—23rd May, 1905.—ARTHUR GEORGE RICH WILLIAMS, of Petone, Wellington, New Zealand, Engineer. Improvements relating to sewing-machines.*

Extract from Specification.—According hereto the cotton or the like for employment in the machine is wound in what I term a "cocoon," the cocoon being approximately the shape of the interior of the shuttle of the machine upon which it is to be used.

[NOTE.—The above extract from the specification is inserted in place of the claims.]

(Specification, 4s. 3d. ; drawing, 1s.)

No. 19586.—14th June, 1905.—CHARLES WILLIAM GORDON, of No. 34 Nelson Road, South Melbourne, Victoria, Australia, Traveller. Improved adjustable pedal-strap for cycles.*

Claims.—(1.) An improved cycle pedal-strap or toe-clip of leather, canvas, or like material, consisting of a centre piece A, having four tails or ends, such as B, cut in one piece in the manner illustrated in Fig. 1, the two sides of centre piece A being cut diagonally to make the front shorter than the back, substantially as and for the purposes specified, and as described and shown in the drawings. (2.) An improved cycle pedal-strap or toe-clip as claimed in Claim 1, in combination with or without the keeper C, such as illustrated in Fig. 2 of the drawings, having two loops for ends B to pass through, the keeper C being riveted to a small piece D near the centre, leaving a space of half an inch between rivet centres for the spike on pedal side to enter between small piece D and outside part of keeper C, substantially as and for the purposes specified and described, and illustrated in the drawings. (3.) The

combination of the parts claimed in the foregoing claims for the purposes specified, substantially as described, and illustrated in Figs. 1 to 8 in the drawings.

(Specification, 6s.; drawings, 3s.)

No. 20182.—17th October, 1905.—JAMES GEORGE TER-HOFSTEEDE, of Sunbury, Victoria, Australia, Saddler. Improved fastening for leggings.*

Claims.—(1.) The curve-shaped hook on the bottom of one of the said rods, which is flattened so that it may fit into the narrow slot on the bottom of the accompanying rod. (2.) The narrow slot on the bottom of the other rod, which is set back so that the rods line when connected. (3.) The curve given to the said rods to effect a tight grip along the folds. (4.) The catch-hook on the top of one of the said rods, which is set back as shown in my drawing, so that the rods line when the other rod is placed in the gullet of the hook.

(Specification, 4s.; drawing, 1s.)

No. 20308.—21st January, 1905.—EDWARD LEWELIN WHITE, Managing Director of the Photochrom Company, Limited, of No. 35 Hosier Lane, Snow Hill, London, England, Photographic Publisher. Improvements in pictorial post-cards, view-books, almanacs, show-cards, and the like.

(NOTE.—This is an application under section 106 of the Act, the date given being the official date of the application in Great Britain.)

Claims.—(1.) A pictorial postal card, view-book, almanac, show-card, or the like, consisting of a frame and body part, a sliding card, a piece of tape or the like connected to the sliding card and to the body part, and a number of smaller cards hinged or connected to the said tape intermediate of its ends in such manner that normally the sliding card covers the smaller hinged cards, but on being partly withdrawn from the frame and body part the hinged cards are exposed and turned over, one after the other, substantially as described. (2.) A pictorial postal card, view-book, almanac, show-card, or the like, as described and shown in Figs. 1, 2, 3, 4, and 5. (3.) A pictorial postal card, view-book, almanac, show-card, or the like, as described and shown in Fig. 6.

(Specification, 4s. 6d.; drawing, 1s.)

No. 20316.—15th November, 1905.—THOMAS HENRY MAPP, of 382 Bourke Street, Surry Hills, near Sydney, New South Wales, Australia, Engineer. Improved apparatus for treating forage.*

Claims.—(1.) In apparatus for treating forage before compression, a casing surrounded by suitable non-conducting material, and containing two or more parallel conveyors or carriers arranged one above the other, and each driven oppositely to the one immediately below it, heating-pipes disposed between the upper and lower aprons of each carrier and at the ends of the casing, one or more feed-openings and a discharge shoot, substantially as described and illustrated. (2.) In apparatus for treating forage before compression, a casing containing two or more parallel conveyors arranged one above the other and driven by sprocket wheels so that each travels oppositely to the one below it, cleaning-brushes in contact with and rotated oppositely to the conveyors, heating-pipes disposed within the casing, and one or more feed-openings and a discharge shoot, substantially as described and illustrated. (3.) In apparatus for treating forage before compression, a carrier consisting of aprons 23, provided with flanges 24, extensions 25, and laps 26, said aprons being bolted to lugs 22 on the links of the endless chain 20, substantially as described and illustrated. (4.) The improved apparatus for treating forage before compression, consisting of the combination and arrangement of the various parts, substantially as described and as illustrated in the drawings.

(Specification, 5s.; drawings, 2s.)

No. 20322.—14th November, 1905.—TAMERLANE VITRIVIOUS WHITMORE, of Christchurch, New Zealand, Grocer. An improved toasting-appliance.*

Claim.—For the purpose indicated, a right-angle-shaped bracket having forward upwardly projecting pieces and rear pieces adapted to act as stilts or stays, substantially as described and as shown.

(Specification, 1s. 3d.; drawing, 1s.)

No. 20605.—18th January, 1906.—WILLIAM GEORGE MEDDINGS, of Remuera, near Auckland, New Zealand, Inspector of New Zealand Telegraphs. An electrical device for recording the breaking of a fire-prevention sprinkler.*

(NOTE.—The title in this case has been altered from that set out in the provisional specification.)

Claims.—(1.) In the electrical device for recording the breaking of a fire-prevention sprinkler, the fitting the insulated wire to the pipe, with the insulation removed from the wire where the wire passes under or around the sprinklers attached to the pipe for the purpose set forth, substantially as described and illustrated. (2.) In the electrical device for recording the breaking of a fire-prevention sprinkler, the combination of the pipe and the sprinklers with the insulated wire fitted thereto, said wire having the insulation removed therefrom where the wire passes under or around the said sprinklers for the purpose set forth, substantially as described and illustrated.

(Specification, 3s.; drawing, 1s.)

No. 20790.—28th February, 1906.—THOMAS GARE, of Bramble Beach, Warren Drive, New Brighton, Chester, England, Engineer. Improvements in and connected with silent and resilient wheels.

Claims.—(1.) In a silent and resilient vehicle-wheel, spokes with taper- or wedge-shaped outer ends and felloe segments with ends shaped to bear against and form a socket for the said outer spoke ends, and the latter extending across the whole width of the felloe or rim, all substantially as and for the purpose set forth. (2.) In a silent and resilient vehicle-wheel, wooden spokes with taper- or wedge-shaped outer ends and felloe consisting of metal-block sockets, the opposing ends of which are shaped to bear against and form a socket for the said outer spoke ends, all substantially as and for the purpose set forth.

(Specification, 4s.; drawing, 1s.)

No. 20845.—14th March, 1906.—JOHN ELLIOT LINDSAY GARDNER, of Palmerston North, New Zealand, Clerk. An invention for heating or drying plates, dishes, or other articles over a gas stove or oven.

Claim.—The attachment of a plate-rack to the hood of a gas-stove, substantially as described.

(Specification, 1s.; drawing, 1s.)

No. 20879.—21st March, 1906.—RHEINISCH-NASSAUISCHE BERGWERKS- & HUTTEN-ACTIEN-GESELLSCHAFT, of Stolberg, Rhenish Prussia, Germany (assignees of Albert Demuth, of Laurenburg on the Lahn, Hesse-Nassau, Germany, Engineer). Round buddle for dressing ores.

Claim.—Round buddle for dressing ores, having a hearth-platform of variable pitch, and consisting of sector-like plates overlaid with a continuous covering, characterized by sector-like plates secured with only one longitudinal edge to hinged and slantwise adjustable arms, and overlapping with the other longitudinal edge the adjacent sector-like plates, and by having at the outer hearth-ring the stuff-cover secured to the means causing the variations in the conic form of the hearth in such a manner as to draw said stuff-covering taut or slaken it according to the adjustment made.

(Specification, 4s. 6d.; drawing, 1s.)

No. 20892.—22nd March, 1906.—WILLIAM HAROLD THOMAS, of 64 Pitt Street, Sydney, New South Wales, Australia, Agent (nominee of William Hermann Scharf, of 156 St. Antoine Street, Montreal, Canada, Manager). Improvements in linotype-machines.

Extract from Specification.—The present improvements have to do particularly with the composing-mechanism. The matrix-releasing mechanism which forms a part of the composing-mechanism generally includes power-supply devices for actuating the same, the finger keys merely serving to place the mechanism under the control of the power-supplying devices. For this purpose it has been customary to employ a continuously rotating drum to co-operate with cams corresponding with the different matrices, which cams were released by the keys so as to come in contact with the drum and be rotated thereby. The provision of all of the cams required for this purpose and of the continuously rotating drum and power connections therefor not only renders the assembly of the machine expensive and difficult in the first

instance, and the separation and removal of the key-board and adjacent parts from time to time inconvenient, but increases to a very great extent the cost of construction. The objection to operating the matrix-releasing mechanism directly from the keys has not been due so much to a hard key-action as to the difficulty of positively releasing the matrices when the keys are operated very quickly. By providing the cams and the continuously operating drum, it mattered not how quickly the keys are operated, since the regular and predetermined interval of time taken up in the revolution of the cams always insured the positive release of the matrices. In accordance with the present invention, means are provided to overcome this objection to the operation of the matrix-releasing mechanism directly from the keys, and these means comprise devices to arrest momentarily the action of the escapements for the matrices. In this way the matrices are always released properly, while the construction of the matrix-releasing mechanism is thereby greatly simplified. Furthermore, new and improved escapements are provided for releasing the matrices, and said escapements are not only shown mounted, as usual, upon the magazine itself, but means are provided for mounting the escapements upon the magazine delivery mouth, whereby a separate set of escapements is not required upon each magazine. Again, the magazine is provided with aligning means, such as adjustable set-screws, whereby it may be quickly placed upon the magazine, the aligning of the magazine upon the adjacent parts becoming thereby automatic. Again, the magazine delivery mouth is adapted so that the magazine can be swung away from it without interfering with any other parts, and without moving any other parts of the machine, and the magazine delivery mouth is rigidly secured to the machine, instead of being made to swing away to permit the removal of the magazine, as heretofore. Still another object of the invention is the provision of an improved matrix-control, whereby the discharge of matrices from any number of channels in the magazine may be regulated—that is, may be permitted only during the composition of alternate lines or during some other predetermined interval.

[NOTE.—The above extract from the specification is inserted in place of the claims.]

(Specification, £1 7s.; drawings, 8s.)

No. 20973.—6th April, 1906.—CATHERINE JANE MCMASTER, of Corfield, North Queensland, Queensland, Australia, Grazing Farmer. An improved head-frame for wind-mills.

Extract from Specification.—The essential of the invention is a frame between whose vertical sides the wheel of the wind-mill revolves, said frame being pivoted at the top and bottom, as described.

[NOTE.—The above extract from the specification is inserted in place of the claims.]

(Specification, 2s.; drawing, 1s.)

No. 20984.—11th April, 1906.—THE DE FOREST WIRELESS TELEGRAPH SYNDICATE, LIMITED, of 6 Princes Street, London, England (assignees of Lee De Forest, of 42 Broadway, New York, United States of America, at present residing at 6 Princes Street, London aforesaid, Electrical Engineer). Improvements in or relating to wireless telegraphy.

Claims.—(1.) A wireless-telegraph oscillation responsive device, in which the sensitive element is a gaseous medium maintained in a condition of molecular activity, substantially as described for the purposes specified. (2.) A wireless-telegraph oscillation responsive device of the kind referred to in Claim 1, in which the gaseous medium is maintained in a condition of molecular activity by heating the same by a flame, substantially as described. (3.) A wireless-telegraph oscillation responsive device of the kind referred to in Claim 1, in which the gaseous medium is maintained in a condition of molecular activity by electrical means, so that said medium will be sensitive to electrical oscillations, substantially as described. (4.) A wireless-telegraph oscillation responsive device of the kind referred to in Claim 3, in which the gaseous medium is enclosed, substantially as described. (5.) A wireless-telegraph oscillation responsive device of the kind referred to in Claim 1, in which suitable salts, such as those of the halogen class, are employed for rendering the gaseous medium more sensitive to electrical oscillations, substantially as described. (6.) A wireless-telegraph oscillation responsive device of the kind referred to in Claim 1, in which the receiving-device is operated by the oscillation detector without the employment of a local battery, substantially as described. (7.) A wireless-telegraph oscillation responsive device of the kind referred to in Claim 1, in which the oscillations to be detected are passed through a coil surrounding the gaseous medium, substantially as described. (8.) Wireless-telegraph oscillation responsive device, having its parts constructed, arranged, and adapted

to operate substantially as described with reference to the several examples illustrated in the drawings for the purposes specified.

(Specification, 10s.; drawings, 2s.)

An asterisk (*) denotes the complete specification of an invention for which a provisional specification has been already lodged.

NOTE.—The cost of copying the specification and drawing has been inserted after the notice of each application. An order for a copy or copies should be accompanied by a post-office order or postal note for the cost of copying.

The date of acceptance of each application is given after the number.

Extracts from the drawings accompanying the foregoing complete specifications appear at the end of this *Gazette*.

J. C. LEWIS,
Deputy Registrar.

Provisional Specifications accepted.

Patent Office,
Wellington, 2nd May, 1906.

APPLICATIONS for Letters Patent, with provisional specifications, have been accepted, as under:—

- No. 20777.—A. Mortland, paper holder and stand.
No. 20814.—G. F. Reynell, stretching wire-wove mattresses.
No. 20827.—M. Squire, fireproof house. (G. Lilienthal.)
No. 20835.—J. Bonner, can for boiling water.
No. 20858.—A. Williams, trolley-pole adjuster.
No. 20859.—A. Williams, tin-opener.
No. 20862.—O. K. Carlson, water-tap.
No. 20894.—T. J. Davenport, rubber spring.
No. 20900.—O. K. Carlson, water-tap.
No. 20901.—O. K. Carlson, protecting water-pipes from frost.
No. 20907.—T. Walters, damper for stoves, &c.
No. 20919.—A. Reid, attaching coulter to plough-beam.
No. 20940.—A. Mackay, ladder-strap.
No. 20945.—A. Potter, pocket tobacco-cutter.
No. 20948.—R. Buck and D. H. K. McGuinness, lever for removing tires.
No. 20950.—J. M. Youngson, swingletree.
No. 20963.—W. Bennet, dress-fastener.
No. 20964.—M. A. Browne, ashpan cinder-sieve.
No. 20965.—W. Clarke and K. Te Huki, braces.
No. 20966.—W. H. Kinvig, nail for packing-case.
No. 20974.—D. Hartwell, flax-treating machine.
No. 20990.—M. Moore and T. J. Heskett, iron and steel manufacture.
No. 20999.—A. Small, teat-cup of milking machine.
No. 21032.—B. W. White, preparing metal plates for colour-printing.

NOTE.—Provisional specifications cannot be inspected, or their contents made known by this office in any way, until the complete specifications in connection therewith have been accepted.

Letters Patent sealed.

LIST of Letters Patent sealed from the 19th April to the 2nd May, 1906, inclusive:—

- No. 18547.—A. L. Hewton, sash raiser and lock. (J. O. Hewton.)
No. 18910.—A. Lowe, weeding-knife.
No. 18928.—J. J. Healy, cream-cooler.
No. 18929.—W. Dall, ball-tester.
No. 18934.—J. B. Jackson, road-plough.
No. 18983.—F. V. Raymond, spreader for dray-chain.
No. 19106.—J. Ramage, acetylene-generator.
No. 19118.—A. H. E. Fischer, heater.
No. 19131.—S. Priest, jun., wall-tie.
No. 19134.—E. D. Bilham, fencing-standard.
No. 19196.—C. Zoeller and J. Hodge, calf-gehörner.
No. 19816.—D. Krmptic, pea-sheller.
No. 20417.—J. Hanlon, engraving plates.
No. 20471.—A. Collier, cheque-form.
No. 20475.—M. B. L. Ehrmann, manufacture of butter.

Letters Patent on which Fees have been paid.

[NOTE.—The dates are those of the payments.]

SECOND-TERM FEES.

- No. 14571.—J. A. Secor, explosion-motor. 21st March, 1906.
No. 14595.—R. McLean, animal-trap. 21st April, 1906.
No. 14694.—T. H. Brown and J. E. Staples, branding-fluid. 18th April, 1906.

No. 14798.—J. Campbell, barge for handling coal. 21st April, 1906.

No. 14801.—Andrews and Beaven, Limited, bag-grip. (W. Andrews.) 24th April, 1906.

No. 14810.—F. J. King, magnetic ore-separator. 18th April, 1906.

No. 14881.—T. S. Mully and W. Sievwright. Preserving and antifouling composition. 25th April, 1906.

No. 14888.—F. Klepetko and W. J. Evans, roasting-furnace. 18th April, 1906.

No. 14934.—W. Rodier, animal-trap. 25th April, 1906.

THIRD-TERM FEES.

No. 11557.—D. Grant and A. Macpherson, closet-seat cover. 24th April, 1906.

No. 11566.—A. Kitson, E. and J. O. Bidwill, J. F. Pease, T. Wardell, H. Kember, S. C. Leary, C. H. Izard, R. H. Rhodes, and T. W. Butcher, vapour-burning lamp. 27th April, 1906.

No. 11621.—Actieselskabet Burmeister and Wains Maskinog Skibsbyggeri, cream-separator. (O. Anderson.) 19th April, 1906.

No. 11680.—The Gramophone and Typewriter, Limited, sound-transmitter. (H. L. Short.) 19th April, 1906.

Subsequent Proprietors of Letters Patent registered.

[NOTE.—The name of the patentee is given in brackets; the date is that of registration.]

ANDREWS and Beaven, Limited, a private company incorporated under the provisions of "The Companies Act, 1903," and having its registered office at No. 60 Moorhouse Avenue, in the City of Christchurch, in the Colony of New Zealand.

No. 6487.—Seed husking and shelling. [W. Andrews and A. W. Beaven.]

No. 6955.—Pressing wool into bales. [J. Moderate.] Registered as proprietors of the license granted to W. Andrews and A. W. Beaven.

No. 12066.—Mixing and preparing manures. [J. Wright, W. Andrews, and A. W. Beaven.] Registered as proprietors of the interest of W. Andrews and A. W. Beaven.

No. 12523.—Chaffcutter. [W. Andrews and A. W. Beaven.]

No. 14218.—Bag-gripping apparatus. [C. Anketell.] Registered as proprietors of the license granted to W. Andrews and A. W. Beaven.

No. 14290.—Cleaner, crusher, &c., for chaffcutter. [W. Andrews and A. W. Beaven.]

No. 14801.—Bag-gripping apparatus. [W. Andrews.]

No. 17211.—Threshing-machine. [W. Andrews and A. W. Beaven.]

No. 17743.—Rye-grass-seed cleaner. [J. B. Waters, W. Andrews, and A. W. Beaven.] Registered as proprietors of the interest of W. Andrews and A. W. Beaven. 30th April, 1906.

No. 15547.—Lamson Store Service Company, Limited, of 20 Cheapside, London, England, Manufacturers. Cash railway. [G. W. Basley—M. S. Giles.] 30th April, 1906.

Metallurgiska Patentaktiebolaget, of Centralpalatset, Stockholm, Sweden.

No. 17343.—Reducing iron-ore.

No. 17344.—Magnetic separation of iron-ore.

No. 17842.—Furnace for burning cement.

No. 18916.—Magnetic ore-separator. [G. Grondal.] 30th April, 1906.

Nos. 20098 and 20099.—Leslie Byron Morres, of Queen Street, Melbourne, Victoria, Manager of Companies. Gold separating and saving. [J. Nicholson.] 30th April, 1906.

Applications for Letters Patent abandoned.

LIST of applications for Letters Patent, with which provisional specifications only have been filed, abandoned (i.e., complete specifications not lodged), from the 19th April to the 2nd May, 1906, inclusive:—

No. 19606.—W. O. Beere, drawing-instrument.

No. 19607.—A. H. Farmer, steam-valve.

No. 19612.—C. J. Good, cuff-protector.

No. 19616.—R. C. White and A. Burt, jun., cock or valve.

No. 19617.—H. Mann, damper for register grate.

No. 19618.—R. W. Jones, music-support for cornet, &c.

No. 19619.—R. Newman, gasholder for limelight purposes.

No. 19625.—C. Suttie, flax-washing.

No. 19626.—A. F. Roy, chair for metal poles, &c.

No. 19636.—R. C. Park, vacant-seat indicator. (R. Wales.)

No. 19637.—J. R. Park, envelope. (T. Johnstone.)

No. 19638.—J. R. Park, envelope-fastening. (D. Robertson.)

No. 19641.—J. Pomeroy, clothes-prop.

No. 19642.—M. Matthews, sharpening-stone box.

No. 19647.—T. F. Brown and H. Clarke, ink-bottle.

No. 19648.—C. J. Royds, hand-saw.

No. 19649.—W. Madder, voting-machine.

No. 19651.—H. C. Thomsen, cocksfoot-thresher.

No. 19653.—H. D. Atkinson, receipt-form.

No. 19656.—G. A. Haydon, wash-up mop.

No. 19657.—E. W. Thurgar, harness-buckle.

No. 19658.—E. W. Thurgar, collar, &c., stud.

No. 19660.—E. McCaffry, boot-heel.

No. 19693.—T. Ritchie, stop-cock.

No. 19694.—F. V. Raymond, clothes-peg.

No. 19695.—F. V. Raymond, clothes-peg.

Applications for Letters Patent void.

APPPLICATIONS for Letters Patent, with which complete specifications have been lodged, void owing to non-acceptance of such complete specifications, from the 19th April to the 2nd May, 1906, inclusive:—
Nil.

Applications for Letters Patent lapsed.

LIST of applications for Letters Patent lapsed, owing to Letters Patent not being sealed, from the 19th April to the 2nd May, 1906, inclusive:—

No. 18613.—W. F. Johns, operating lift-doors.

No. 18638.—F. A. Rich, recovery of gold and silver. (S. B. Christy.)

No. 18647.—Globe Proprietary Company, Limited, ham-mock-support. (E. H. Littlejohn—W. H. Morehouse.)

No. 18651.—J. Anderson, pressure-appliance for cheese-press.

No. 18656.—C. Brake, cattle surgical-instrument.

No. 18657.—B. Gibbs, spreader for traces.

No. 18659.—A. Billens, spray-pump attachment.

No. 18685.—A. H. Tinkham, ear-punch.

Letters Patent void.

LETTERS Patent void through non-payment of renewal fees and through expiry of term of fourteen years, from the 19th April to the 2nd May, 1906, inclusive:—

THROUGH NON-PAYMENT OF SECOND-TERM FEES.

No. 14451.—C. E. Bamford, means to prevent children falling out of bed.

No. 14456.—J. C. Moore, sewing-machine.

No. 14462.—W. Currie, ballast-spreading machine.

No. 14464.—G. J. Perotti, amalgamator.

No. 14465.—J. L. Wilson, clothes line and peg. (J. Murray.)

No. 14483.—J. Webb, wire-strainer.

No. 14485.—W. G. Dodd, ore-concentrator.

No. 14486.—J. Dingwall, canister.

THROUGH NON-PAYMENT OF THIRD-TERM FEES.

No. 11319.—W. M. Turner, horse-race starter.

No. 11325.—C. S. Bradley and C. B. Jacobs, manufacturing salts of barium, &c.

No. 12014.—W. Hildesheim, manufacture of cocoa.

THROUGH EXPIRY OF TERM.

No. 5520.—A. E. Decoufflé, cigarette-machine.

No. 5524.—L. M. Jones and J. K. Wedlake, sheaf-carrier.

No. 5525.—Massey-Harris Company, Limited, binder. (L. M. Jones and J. K. Wedlake.)

Design registered.

A DESIGN has been registered in the following name on the date mentioned:—

No. 285.—Joseph Wilson, of 12 Barbour Street, Christchurch, in the Colony of New Zealand, Manufacturer. Class 1. 27th April, 1906.

Applications for Registration of Trade Marks.

Patent Office,
Wellington, 2nd May, 1906.

APPLICATIONS for registration of the following Trade Marks have been received. Notice of opposition to the registration of any of these applications may be lodged at this office within two months of the date of this Gazette. Such notice must be in duplicate, and accompanied by a fee of £1.

No. of application : 5808.
Date : 28th February, 1906.

TRADE MARK.



The essential particulars of this trade mark are the device and the word "Pattisyasnil"; and any right to the exclusive use of the added matter is disclaimed.

NAME.

THE P.B.C. COMPANY, of 8 Linden Court, Market and Castlereagh Streets, Sydney, New South Wales.

No. of class : 48.
Description of goods : Toilet preparation.

No. of application : 5866.
Date : 31st March, 1906.

TRADE MARK.



NAME.

WHITE AND Co., LIMITED, of 193 Princes Street, Dunedin, in the Colony of New Zealand, Merchants.

No. of class : 42.
Description of goods : Rabbits and hares.

No. of application : 5868.
Date : 2nd April, 1906.

TRADE MARK.

The word
"DRENCHO."

NAME.

A. AND E. DAVIES, of Wanganui, in the Colony of New Zealand, Chemists, trading as "The Davies Pharmacy."

No. of class : 2.
Description of goods : Cattle medicines, as prepared by them in pharmacy.

No. of application : 5884.
Date : 6th April, 1906.

TRADE MARK.



EXTRA CUVÉE DE RÉSERVE.
1898

Pol Roger & Co.
Epernay
CHAMPAGNE

The essential particular of the trade mark is as follows: the combination of devices; and applicants disclaim any right to the exclusive use of the added matter, except in so far as it consists of their own name and address.

NAME.

POL ROGER AND Co., of Epernay, in France, Wine Growers and Shippers.

No. of class : 43.
Description of goods : Champagne.

No. of application : 5886
Date : 7th April, 1906.

TRADE MARK.



The essential particulars of this trade mark are the words and design "Golden Harp"; and any right to the exclusive use of the words "Coupon Tea" is disclaimed.

NAME.

W. M. LUXFORD AND Co., of Aramoho, Wanganui, in the Colony of New Zealand.

No. of class : 42.
Description of goods : Tea.

No. of application : 5899.
Date : 12th April, 1906.

TRADE MARK.

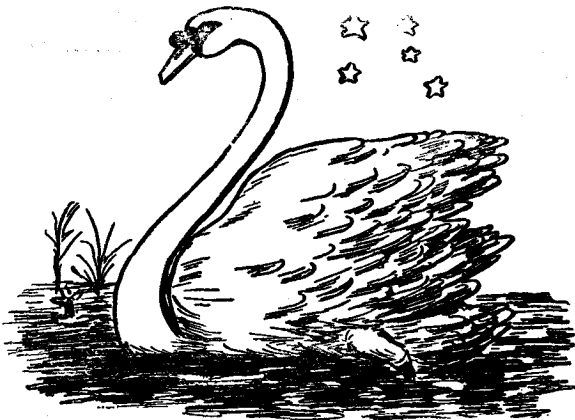

NAME.

THE SOUTHERN CROSS BISCUIT COMPANY, LIMITED, of Wanganui, in the Colony of New Zealand, Biscuit, Lolly, Bread, and Flour Millers.

No. of class : 42.

Description of goods : Biscuits, cakes, confectionery, cereals, and all cereal meals and foods.

No. of application : 5899.
Date : 17th April, 1905.

TRADE MARK.

The word

KIA-ORA.

NAME.

EDWARD STRONG, of Haslett Street, Eden Terrace, near the City of Auckland, in the Provincial District of Auckland, in New Zealand, Gum-sorter.

No. of class : 3.

Description of goods : Chemical substances prepared for use in medicine and pharmacy, such as plasters, and pile-cure.

No. of application : 5902.
Date : 17th April, 1906.

TRADE MARK.



The essential particulars of the trade mark are the following : the combination of devices and the word "Marigold"; and the applicants disclaim any right to the exclusive use of the added matter, except their name.

NAME.

GODFREY PHILLIPS AND SONS, of 112 Commercial Street, London, England, Cigar and Tobacco Manufacturers.

No. of class : 45.

Description of goods : Tobacco, cigars, and cigarettes.

No. of application : 5904.
Date : 17th April, 1906.

TRADE MARK.



The essential particulars of the trade mark are the following : the combination of devices and the words "Virgin Gold"; and the applicants disclaim any right to the exclusive use of the added matter except their name.

NAME.

GODFREY PHILLIPS AND SONS, of 112 Commercial Street, London, England, Cigar and Tobacco Manufacturers.

No. of class : 45.

Description of goods : Tobacco, cigars, and cigarettes.

No. of application : 5905.
Date : 17th April, 1906.

TRADE MARK.

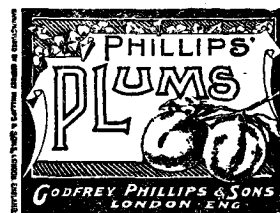

The essential particulars of the trade mark are the following : the combination of devices and the word "Plums"; and the applicants disclaim any right to the exclusive use of the added matter except their name.

NAME.

GODFREY PHILLIPS AND SONS, of 112 Commercial Street, London, England, Cigar and Tobacco Manufacturers.

No. of class : 45.

Description of goods : Tobacco, cigars, and cigarettes.

No. of application : 5908.
Date : 18th April, 1906.

TRADE MARK.

The word

"ATLAS."

NAME.

CAMERON BROS. AND COMPANY, a corporation of 132 Market Street, San Francisco, California, United States of America.

No. of class : 6.

Description of goods : Gas, gasoline, and oil engines.

No. of application : 5909.
Date : 18th April, 1906.

The word **TRADE MARK.**

"IMPERIAL."

NAME.

CAMERON BROS. AND COMPANY, a corporation of 132 Market Street, San Francisco, California, United States of America.

No. of class : 6.
Description of goods : Gas, gasolene, and oil engines.

No. of application : 5911.
Date : 19th April, 1906.

TRADE MARK.



NAME.

SADLER, FIRTH, AND ROSS, LIMITED, of 26 Great Guildford Street, Southwark, London, S.E., England, Manufacturers.

No. of class : 42.
Description of goods : Substances used as food or as ingredients in food.

No. of application : 5912.
Date : 19th April, 1906.

The word **TRADE MARK.**

PRANA

NAME.

AÉRATORS LIMITED, of 55 Broad Street Avenue, London, England (Registered Offices), and Angel Road, Edmonton, London aforesaid, "Sparklets" Manufacturers.

No. of class : 6.
Description of goods : All goods included in this class.

NOTE.—Class 6 is for "Machinery of all kinds, and parts of machinery, except agricultural and horticultural machines included in Class 7."

No. of application : 5913.
Date : 19th April, 1906.

The word **TRADE MARK.**

PRANA

NAME.

AÉRATORS LIMITED, of 55 Broad Street Avenue, London, England (Registered Offices), and Angel Road, Edmonton, London aforesaid, "Sparklets" Manufacturers.

No. of class : 13.
Description of goods : All goods included in this class.
NOTE.—Class 13 is for "Metal goods not included in other classes."

No. of application : 5915.
Date : 20th April, 1906.

TRADE MARK.

The words **SIGALL'S GOLDEN CROP.**

NAME.

SIGALL AND Co., of Manners Street, Wellington, in the Colony of New Zealand.

No. of class : 45.
Description of goods : Tobacco, cigars, cigarettes, and snuff.

No. of application : 5916.
Date : 24th April, 1906.

TRADE MARK.

Does Not Smart—Soothes Eye Pain.

Murine is Astringent, Antiseptic, and an Eye Tonic. Safe to use in most delicate case. Both Infant and Adult find Eye comfort in Murine. Does not smart, but soothes Eye Pain. Murine is not an Eye Water but a carefully compounded Remedy that cures Eyes.

Directions. For Inflamed, Weak, sore or Itched Eyes, Eyelids, ulcers on the eyeballs, granulated lids, or scales on the lids, drop 2 drops in each eye every 10 minutes to two hours; less frequently as the case improves. Murine is perfectly harmless in any case.

MURINE Strengthens Weak EYES.

The essential particulars of this trade mark are the word "Murine" and the device; and any right to the exclusive use of the added matter is disclaimed.

NAME.

THE MURINE EYE REMEDY COMPANY, a corporation organized and existing under and by virtue of the laws of the State of Illinois, United States of America, of Masonic Temple, Chicago, Illinois, United States of America, Patent-medicine Proprietors.

No. of class: 3.

Description of goods: A liquid remedy to strengthen the eyes, being a medicated preparation for human use.

No. of application: 5917.

Date: 24th April, 1906.

TRADE MARK.

The word

EMDECA.

NAME.

THE EMDECA METAL DECORATING COMPANY, LIMITED, of 97 Queen Victoria Street. London. E.C., England.

No. of class: 17.

Description of goods: Enamelled zinc sheets used for panelling walls, &c.

No. of application: 5920.

Date: 25th April, 1906.

TRADE MARK.



The essential particulars of this trade mark are the three fern-fronds having their stalk-ends tied together by a piece of flax, and the word "Fern"; and any right to the exclusive use of the added matter is disclaimed.

NAME.

HAROLD LUCIEN KOEFOED, of the City of Auckland, in the Provincial District of Auckland, in the Colony of New Zealand, Manufacturer.

No. of class: 42.

Description of goods: Baking-powder, custard-powder, egg-powder, confectionery, cornflour, cordials, tinned fruits, jams, marmalade, jellies, pickles, sauce, vinegar, ketchup, egg-preservative, lime-juice, chutney, curry-powder, and flavouring-essences.

No. of application: 5922.

Date: 25th April, 1906.

TRADE MARK.

ATLAS
BOILER PRESERVATIVE E.



The essential particulars of this trade mark are the device and the word "Atlas"; and any right to the exclusive use of the added matter is disclaimed.

NAME.

GEORGE SINCLAIR ROBERTSON, of Castlecliff, Wanganui, in the Colony of New Zealand.

No. of class: 1.

Description of goods: Atlas boiler preservative E.

J. C. LEWIS,
Deputy Registrar.

Trade Marks registered.

- LIST of Trade Marks registered from the 19th April to the 2nd May, 1906, inclusive:—
- No. 4497; 5690.—Lever Bros., Limited; Class 47. (*Gazette* No. 2, of the 11th January, 1906.)
 - No. 4498; 5691.—Lever Bros., Limited; Class 48. (*Gazette* No. 2, of the 11th January, 1906.)
 - No. 4499; 5702.—Lever Bros., Limited; Class 47. (*Gazette* No. 2, of the 11th January, 1906.)
 - No. 4500; 5703.—Lever Bros., Limited; Class 48. (*Gazette* No. 2, of the 11th January, 1906.)
 - No. 4501; 5704.—Lever Bros., Limited; Class 47. (*Gazette* No. 2, of the 11th January, 1906.)
 - No. 4502; 5705.—Lever Bros., Limited; Class 48. (*Gazette* No. 2, of the 11th January, 1906.)
 - No. 4503; 5753.—A. R. Hislop; Class 47. (*Gazette* No. 10, of the 8th February, 1906.)
 - No. 4504; 5738.—L. and C. Hardtmuth; Class 39. (*Gazette* No. 10, of the 8th February, 1906.)
 - No. 4505; 5739.—L. and C. Hardtmuth; Class 39. (*Gazette* No. 10, of the 8th February, 1906.)
 - No. 4506; 5756.—A. Tyree and Co.; Class 38. (*Gazette* No. 10, of the 8th February, 1906.)
 - No. 4507; 5374.—The J. B. Ford Company; Class 1. (*Gazette* No. 96, of the 2nd November, 1905.)
 - No. 4508; 5375.—The J. B. Ford Company; Class 1. (*Gazette* No. 96, of the 2nd November, 1905.)
 - No. 4509; 5376.—W. T. Murray and Co., Limited; Class 47. (*Gazette* No. 67, of the 13th July, 1905.)
 - No. 4510; 5381.—Irvine and Stevenson's St. George Company, Limited; Class 42. (*Gazette* No. 88, of the 5th October, 1905.)
 - No. 4511; 5486.—The Christchurch Meat Company, Limited; Class 4. (*Gazette* No. 88, of the 5th October, 1905.)
 - No. 4512; 5487.—The Christchurch Meat Company, Limited; Class 42. (*Gazette* No. 88, of the 5th October, 1905.)
 - No. 4513; 5529.—Brown, Ewing, and Co., Limited; Class 38. (*Gazette* No. 88, of the 5th October, 1905.)

No. 4514; 5530.—Irvine and Stevenson's St. George Company, Limited; Class 42. (*Gazette* No. 96, of the 2nd November, 1905.)

No. 4515; 5532.—W. T. Murray and Co., Limited; Class 42. (*Gazette* No. 110, of the 14th December, 1905.)

No. 4516; 5533.—W. T. Murray and Co., Limited; Class 42. (*Gazette* No. 110, of the 14th December, 1905.)

No. 4517; 5534.—W. T. Murray and Co., Limited; Class 42. (*Gazette* No. 110, of the 14th December, 1905.)

No. 4518; 5565.—Brown, Ewing, and Co., Limited; Class 38. (*Gazette* No. 96, of the 2nd November, 1905.)

No. 4519; 5573.—Irvine and Stevenson's St. George Company, Limited; Class 42. (*Gazette* No. 96, of the 2nd November, 1905.)

No. 4520; 5574.—Irvine and Stevenson's St. George Company, Limited; Class 47. (*Gazette* No. 96, of the 2nd November, 1905.)

No. 4521; 5676.—Lamson Paragon Supply Company of Australasia Proprietary, Limited; Class 39. (*Gazette* No. 110, of the 14th December, 1905.)

Trade Mark Renewal Fees paid.

FEEES paid for the renewal of the undermentioned Trade Marks for fourteen years from the dates first mentioned:—

No. 455/330.—25th April, 1906.—T. Hinshelwood, of Glasgow, Scotland. 18th April, 1906.

No. 458/379.—26th April, 1906.—H. Brace and Co., Limited, of Dunedin, N.Z. 21st April, 1906.

No. 470/493.—17th May, 1906.—Mellin's Food Company for Australia and New Zealand, Limited, of London, Eng. 19th April, 1906.

Subsequent Proprietors of Trade Marks registered.

[NOTE.—The name of the former proprietor is given in brackets. The date is that of registration.]

NO. 5322-4198.—Alphonso Henry Redwood, of the City of Wellington, in the Colony of New Zealand, Salesman. [J. Dixon.] 28th March, 1906.

No. 5517/4485.—Thomas Trim, of Christchurch, in the Colony of New Zealand. [M. J. Gill.] 30th April, 1906.

Trade Marks removed from the Register

TRADe Marks removed from the Register, owing to the non-payment of the renewal fees, from the 19th April to the 2nd May, 1906, inclusive:—

No. 397/427.—19th January, 1892.—N. A. Larney, of Lauriston, Morrinsville, N.Z. Class 2.

No. 401/333.—26th January, 1892.—Scarborough, Nephew, and Co., of Halifax, Eng. Class 34.

No. 403/538.—1st February, 1892.—The New Zealand Dairy Supply Company, Limited, of Dunedin, N.Z. Class 42.

Request for Correction of Clerical Error allowed.

THE request to correct clerical error in application for Trade Mark No. 5704—Lever Bros., Limited (advertised in Supplement to *New Zealand Gazette* No. 2, of the 11th January, 1906)—has been allowed.

Advertisements.

ADVERTISEMENTS are charged at the rate of 6d. per line for the first insertion, and 3d. per line for the second and any subsequent insertion.

All advertisements should be written on one side of the paper, and signatures, &c., should be written in a legible hand.

The number of insertions required must be written across the face of the advertisement.

Communications should be addressed to the Government Printer, Wellington, to whom post-office money-orders should be made payable. Cheques should be crossed "Public a/c," and exchange added.

Postage or duty stamps cannot be received in payment from any place at which postal notes or post-office orders are issued.

Prepayment may be demanded in any case. In order to prevent delay in publication a sufficient remittance should accompany every advertisement. Any surplus will be returned with receipted account.

By Authority: JOHN MACKAY, Government Printer, Wellington.

ILLUSTRATIONS OF INVENTIONS.

[These illustrations refer to the complete specifications accepted, and advertised in this *Gazette*.]

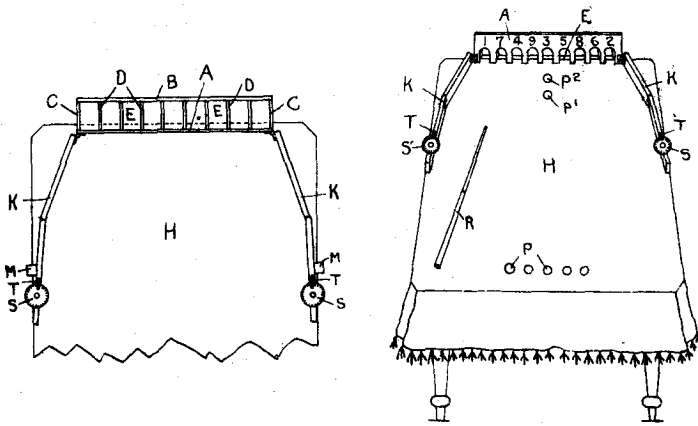

18975
Wiley and Gray. Game.

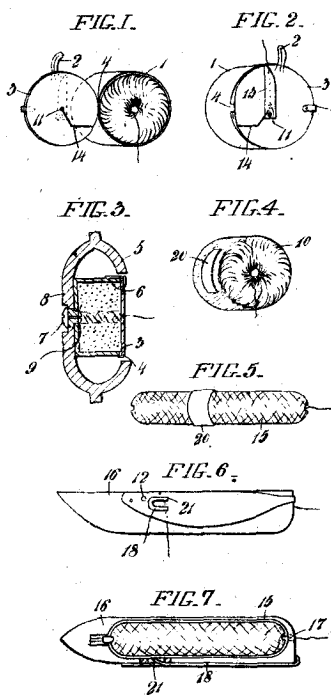

19506
Williams. Sewing-machine.

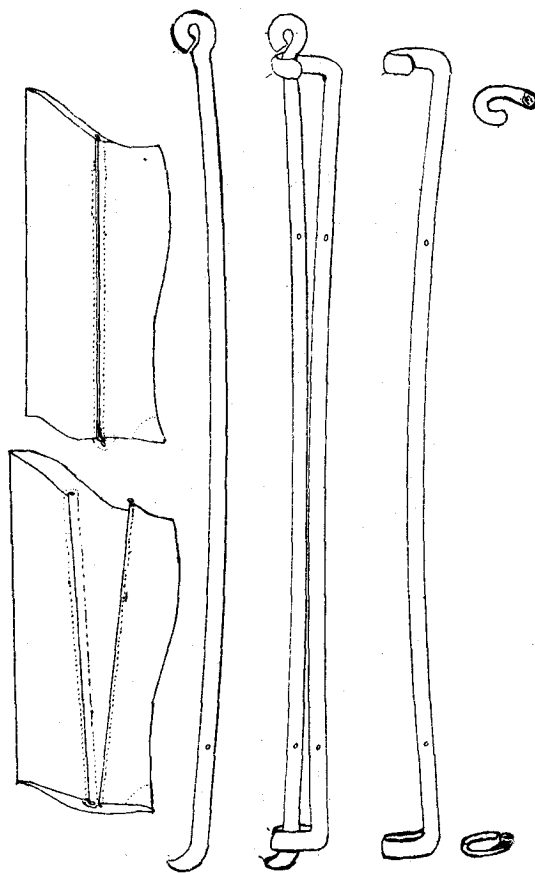

20182
ter-Hofstede. Legging-fastener.

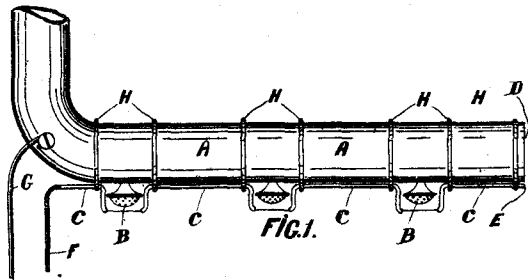

20805
Meddings. Fire-sprinkler Breakage-recorder.

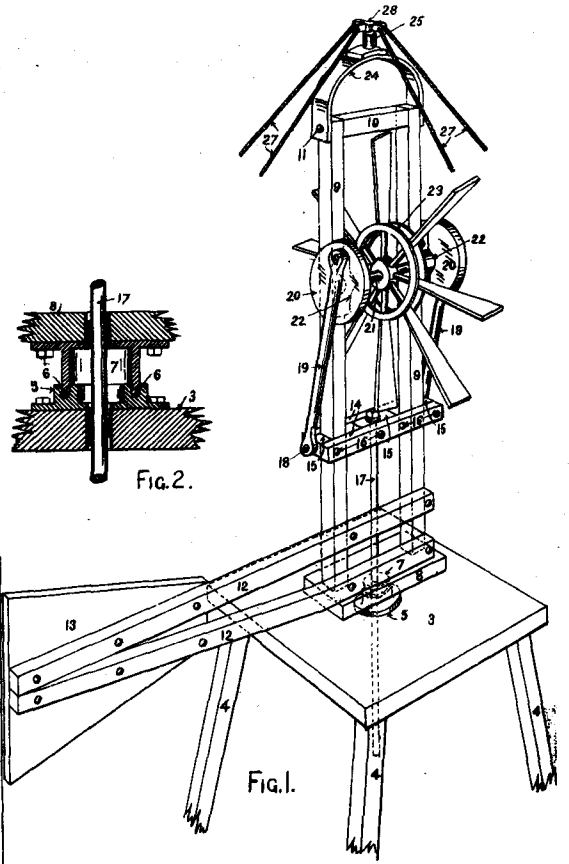

20973
McMaster. Windmill.

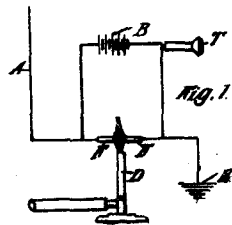
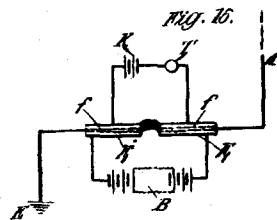
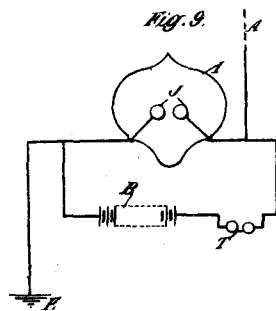
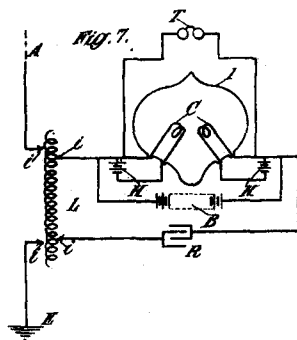

20984
The De Forest Wireless Telegraph Syndicate (Limited). Wireless
Telegraphy. (De Forest.)

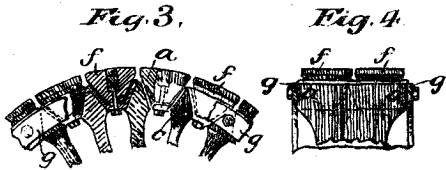

20790
Gare. Wheel.

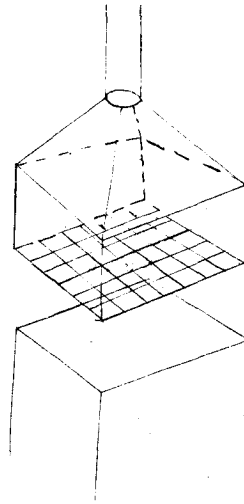

20845
Gardner. Plate-dryer.

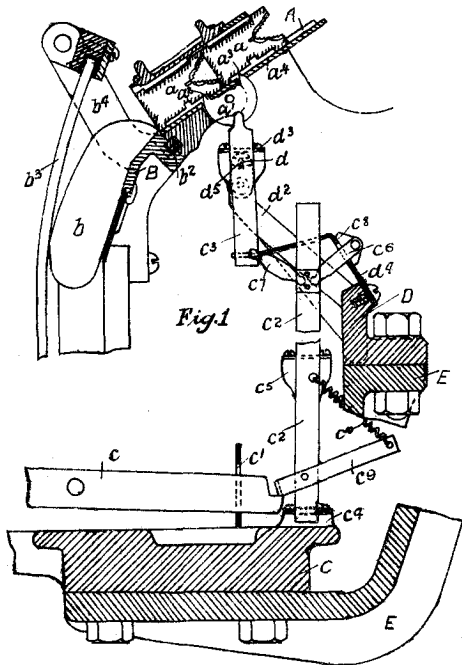

20892
Thomas. Linotype Machine. (Scharf.)

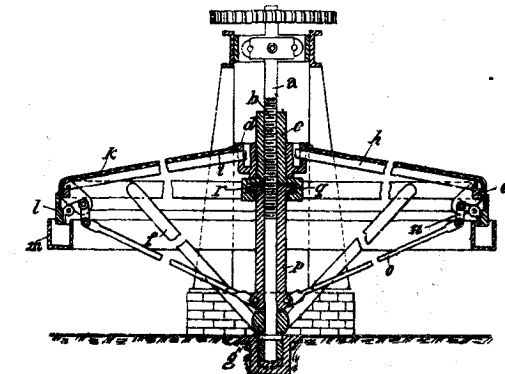
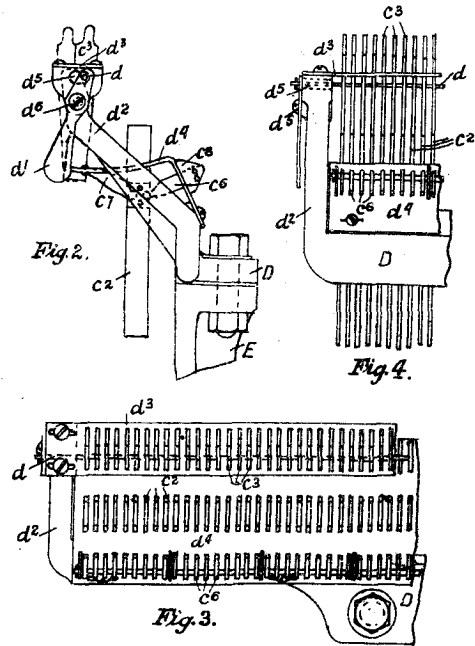

20879
Rheinisch-Nassauische Bergwerks and Hütten-Actien-Gesellschaft.
Ore-dresser. (Demuth.)

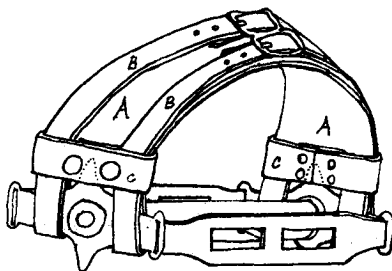
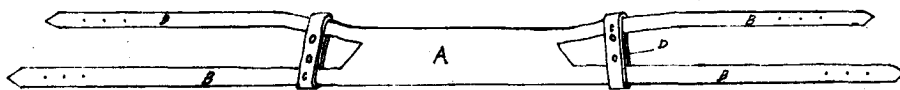

19588
Gordon. Cycle-pedal Strap.

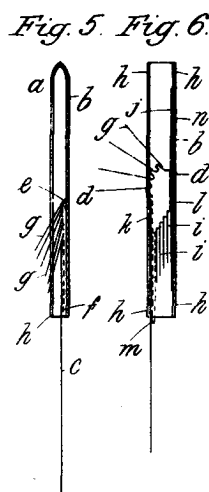
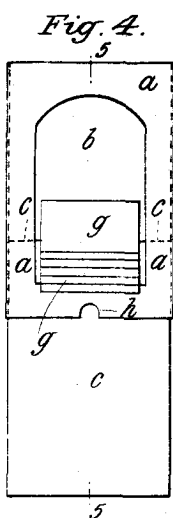
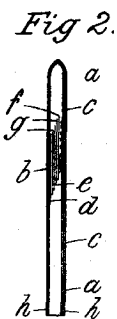
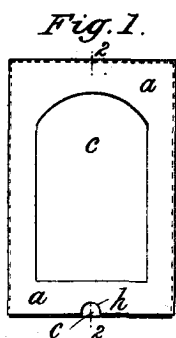

20308
White. Post-card, &c.

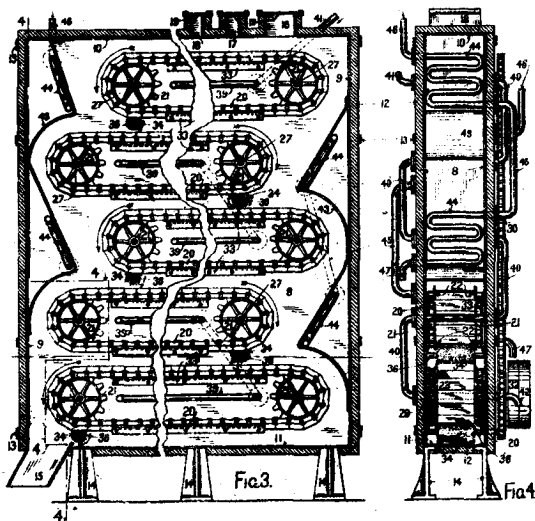

20316
Mapp. Forage-treatment.

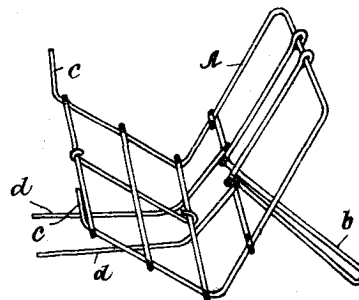

20322
Whitmore. Toasting-appliance.